

Contenitore liquido sanificante

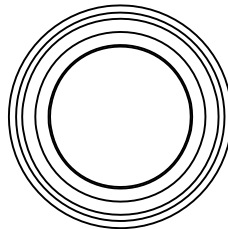

SUPPORTO PORTABOMBOLA CO2

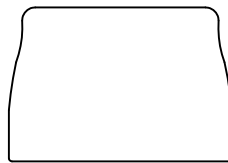
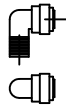
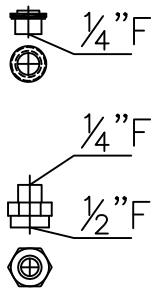
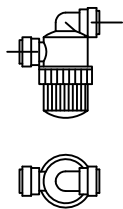
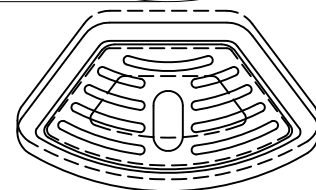
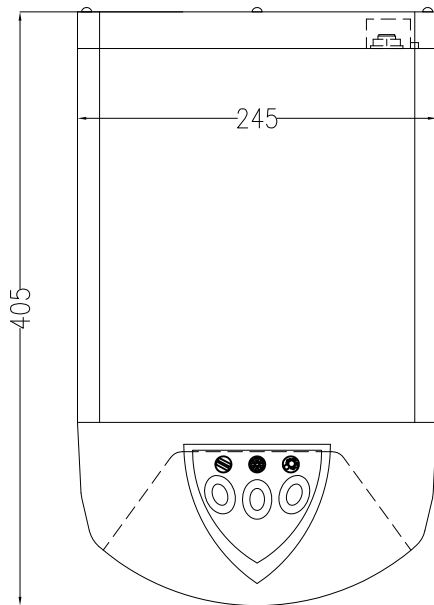

Le dimensioni sono da considerarsi indicative e non impegnative e potranno subire delle variazioni senza preavviso.

Rev.n°	Descrizione revisione	Data revisione	Approv.	
		Cillichemie Italiana via Plinio 59 - Milano - Tel. 02-2046343		
		CILLIT-AQUA DREAM FRIZZ T	Data 28/04/08	Dis. A.L.
		Cod.12127AA	Scala	Approv.
			Disegno N°	Pos. N°
A termine di legge il presente disegno non puo' essere ricopiato ne' riprodotto ne' comunicato anche solo parzialmente ad altra persona o Ditta				